

Input Bias Offset
Input Offset Current
Offset Voltage

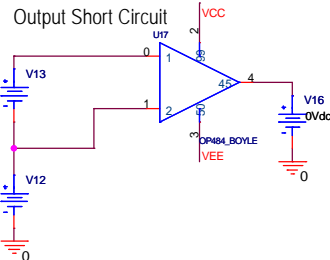

Output Swing

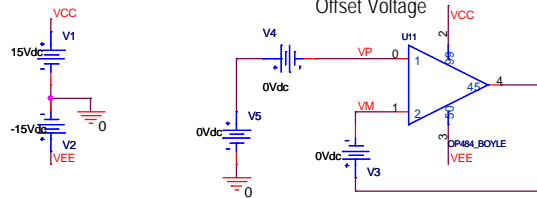
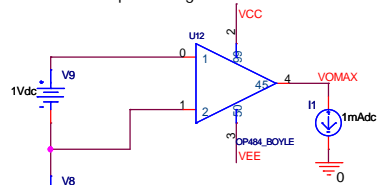

Offset Swing

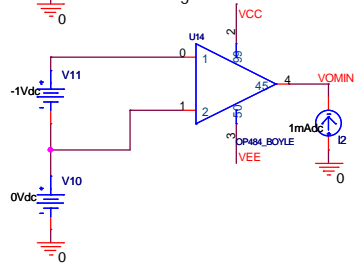

Slew Rate

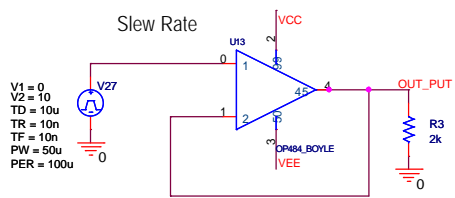

Power Supply Rejection Ratio

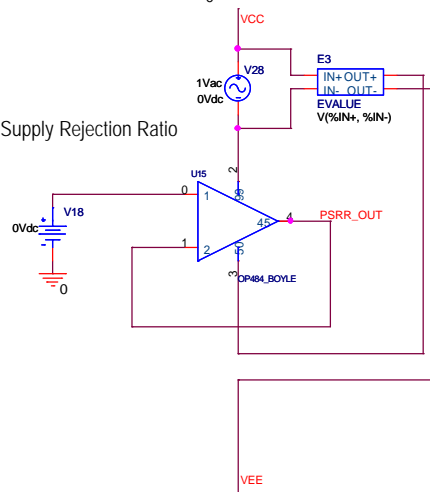

Output Short Circuit

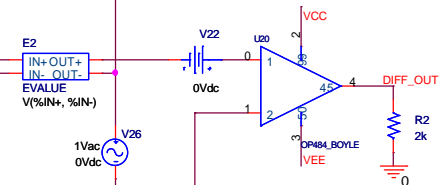
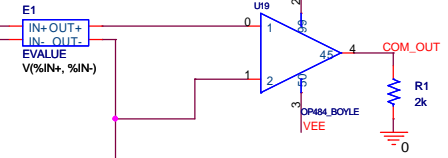
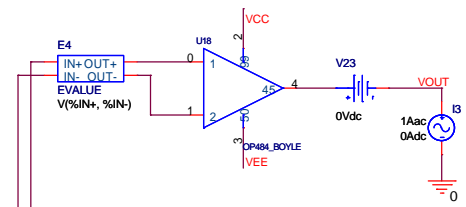
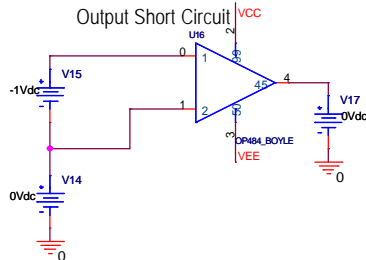

Common Mode Rejection
Gain Bandwidth Product
Excess Phase
Open Loop Gain

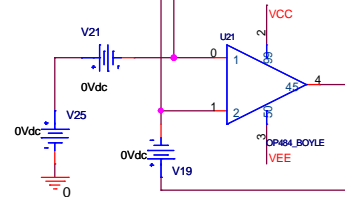

Title		
<Title>		
Size	Document Number	Rev
B	<Doc>	<RevC>
Date: Wednesday, January 05, 2005		Sheet 1 of 1