

Input Bias Offset
Input Offset Current
Offset Voltage

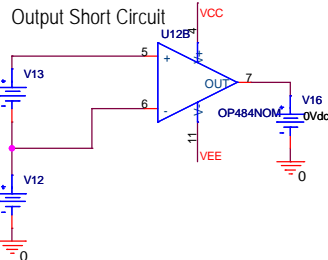

Output Swing

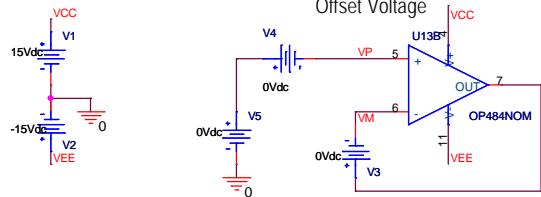
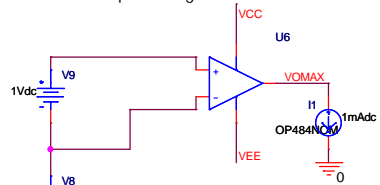

Offset Swing

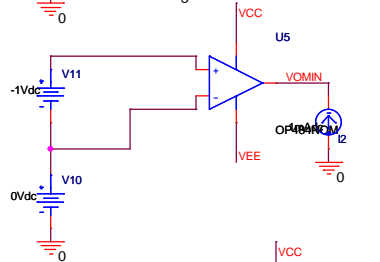

Slew Rate

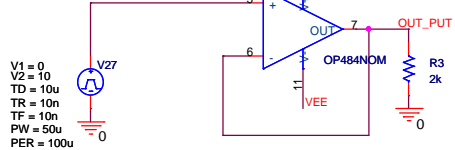

V1 = 0
V2 = 10
TD = 10u
TR = 10n
TF = 10n
PW = 50u
PER = 100u

Power Supply Rejection Ratio

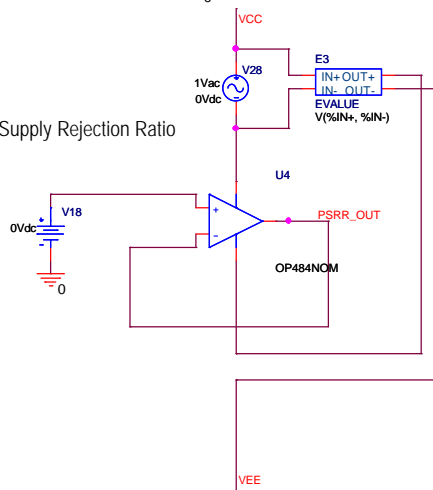

Output Short Circuit

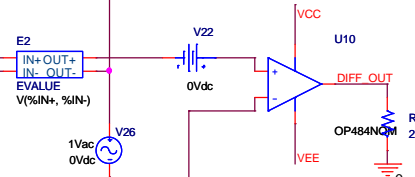
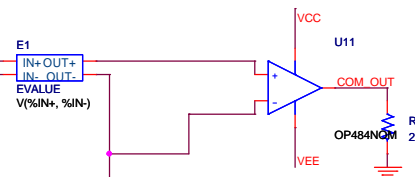
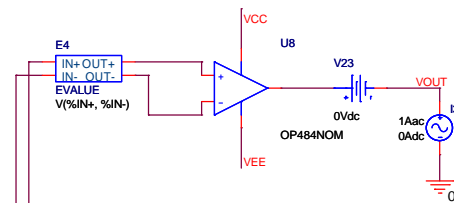
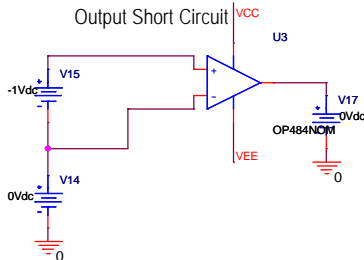

Common Mode Rejection
Gain Bandwidth Product
Excess Phase
Open Loop Gain

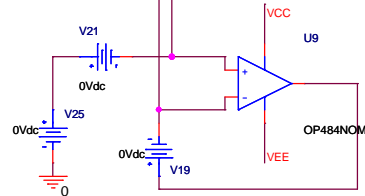

Title		
<Title>		
Size	Document Number	Rev
B	<Doc>	<RevC>
Date: Friday, January 07, 2005		Sheet 1 of 1