

Input Bias Offset
 Input Offset Current
 Offset Voltage

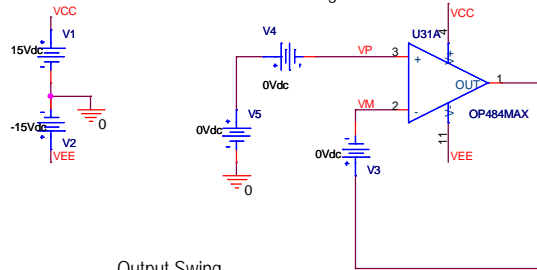

Output Short Circuit

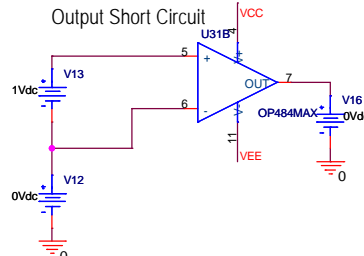

Output Swing

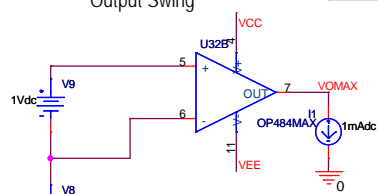

Offset Swing

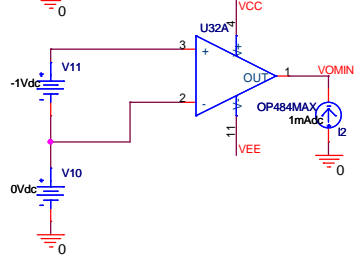

Slew Rate

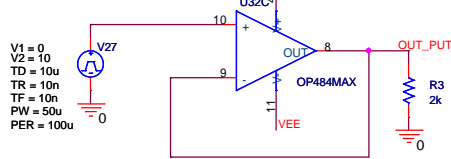

V1 = 0
 V2 = 10
 TD = 10u
 TR = 10n
 TF = 10n
 PW = 50u
 PER = 100u

Output Short Circuit

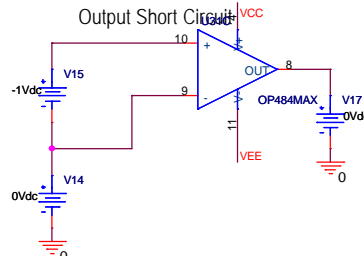

Power Supply Rejection Ratio

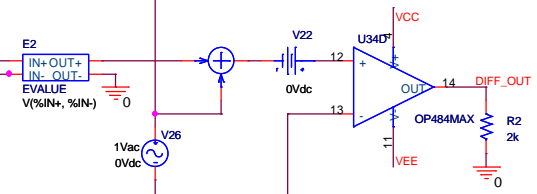
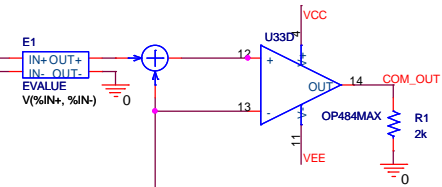
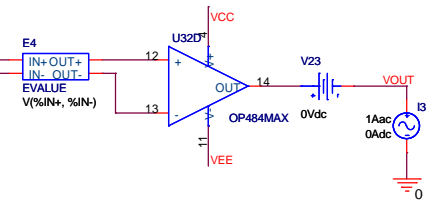
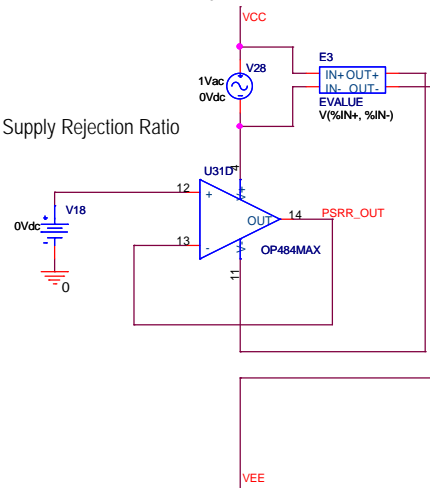

Common Mode Rejection
 Gain Bandwidth Product
 Excess Phase
 Open Loop Gain

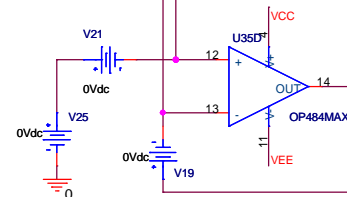

Title		
OP484NOM_TEST		
Size	Document Number	Rev
B	<Doc>	<RevC>
Date:	Monday, February 14, 2005	Sheet 1 of 1